

MRA-7/5

Adaptor plate Cetop 5 to Cetop 7
CETOP 7 / NG16

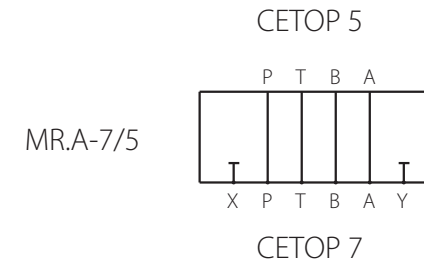

Technical specifications	
Material	EN1A
Pressure	400 bar max
Weight	3.60 kg
Supplied with seals and screws	

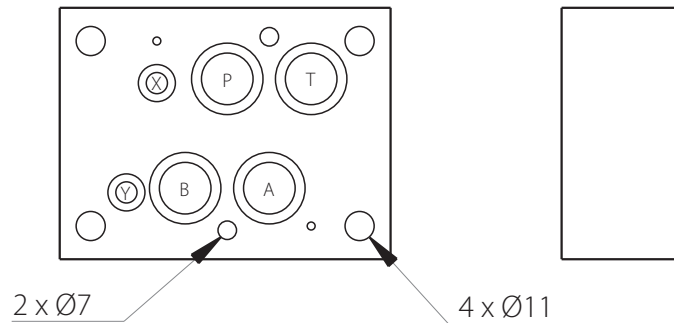
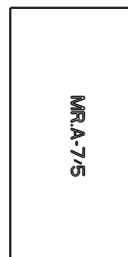
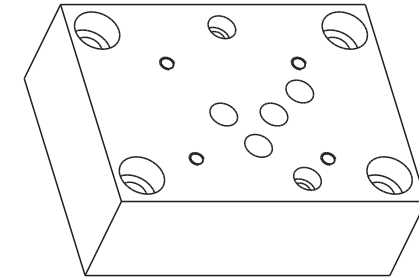
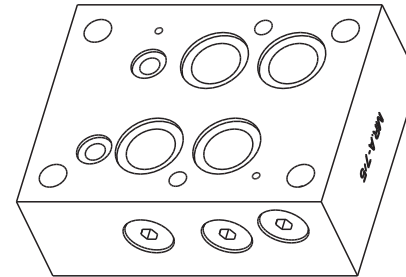
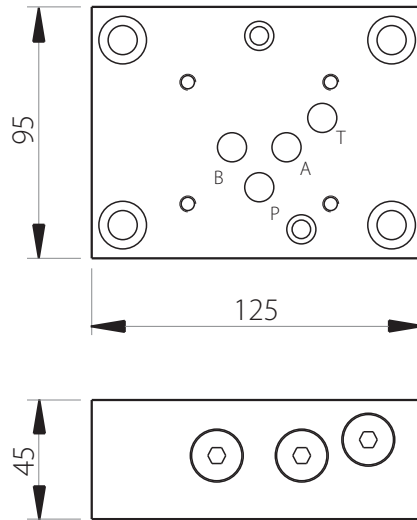